

ONLY FOR INFORMATION

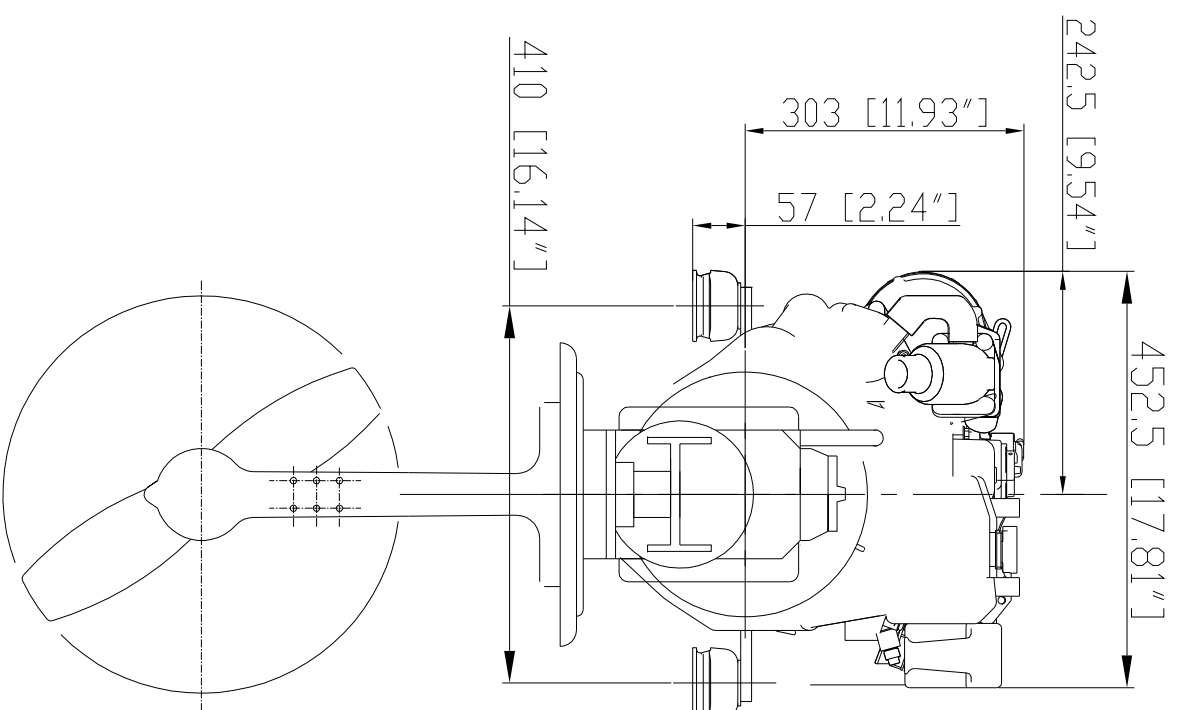

N2.14 SAIL DRIVE 120S  
 PLAN D'ENCOMBREMENT  
 Ech. 1/10  
 le 13-10-10

